

VSV 250-710

VSVI 311-710

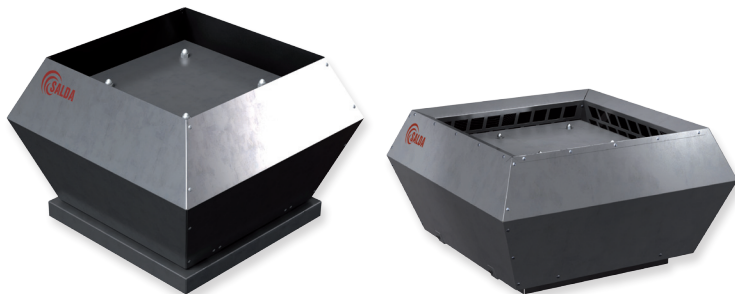

Roof fans

Stoginiai ventilatoriai

Wentylatory dachowe - wyrzut pionowy

Крышные вентиляторы



Roof fans with vertical discharge are used to extract air from different premises. Motorised impeller is protected with a meshwork grill which offers protection against external objects that could cause mechanical damage to the impeller. Not suitable for polluted air, aggressive and explosive gases.

Plastic impeller with backward curved blades, VSV/VSVI 710 impeller made from steel.

VSVI sound insulation: mineral wool, 50 mm thickness.

Motor: external rotor, motor protection built-in thermal contact, maintenance free ball bearings.

Housing: made of galvanized steel. Optionally can be made of aluminium.



Stoginiai ventilatoriai, naudojami oro ištraukimui iš patalpos. Sparnuotė uždengta tinklo grotelėmis, apsaugančiomis ją nuo pašalinių daiktų, galinčių patekti iš aplinkos ir pažeisti sparnuotę mechanškai. Nenaudojami užteršto oro, agresyvių, sprogių dujų transportavimui.

Sparnuotė: atgal lenktais sparneliais, plastikinė sparnuotė.

Variklis: išorinis rotorius, tiesioginė pavara, integruota termokontaktinė variklio apsauga, ilgai tarnaujantys nereikalaujantys priežiūros guoliai.

Korpusas: iš cinkuotos skardos. Galima pasirinkti modelį VSV AL, kuris pagamintas iš aliuminio.

VSVI ir VSVI AL garso izoliacija: 50mm mineraline vata.



Wentylatory dachowe z pionowym wyrzutem służą do wyciągu powietrza z różnych pomieszczeń. Wirniki są osłonięte blachą perforowaną która chroni przed zewnętrznymi czynnikami, które mogą powodować mechaniczne uszkodzenie wirnika.

Nie nadają się do zastosowań w środowiskach agresywnych chemicznie oraz zagrożonych wybuchem. Nie zaleca się stosować w instalacjach zanieczyszczonych cząstkami stałymi, pyłami i odpadami technologicznymi.

Nie stosować w instalacjach oddymiania, przeciwpożarowych, spalinyowych.

Wirnik: plastikowy z łopatkami wygiętymi do tyłu, dla modeli VSV / VSVI 710 wirnik wykonany ze stali.

Silnik: wydajne i ciche silniki z wirnikiem zewnętrznym, zabezpieczenie z wbudowanym bezpiecznikiem termicznym, bezobsługowe łożyska kulkowe.

Korpus: wykonany z ocynkowanej stali - opcjonalnie wykonane z aluminium.

VSVI - izolacja akustyczna : wełna mineralna o gr. 50 mm



Крышные вентиляторы для вытяжки воздуха из помещений. Крыльчатка закрыта сетчатой решёткой, защищающей её от падающих извне посторонних предметов, способных механически повредить крыльчатку. Не используются при транспортировке загрязнённого воздуха, агрессивных, взрывоопасных газов.

Крыльчатка: загнутые назад лопатки, сделано из пластика.

VSVI звукоизоляция: каменная вата, толщиной 50 мм.

Двигатель: наружный ротор, прямая передача, встроенные термомоменты двигателя, не требующие ухода подшипники с длительным сроком службы.

Корпус: оцинкованной жести. Может быть изготовлено и из алюминия.

Accessories

Single phase speed controller	Three phase speed controller	Single phase speed controller	Roof curb	Roof curb	Flange-adapter
TGRV p. 138	TGRT p. 139	ETY/MTY p. 141	KS-K p.147	KSP-K p. 146	FSV p. 155

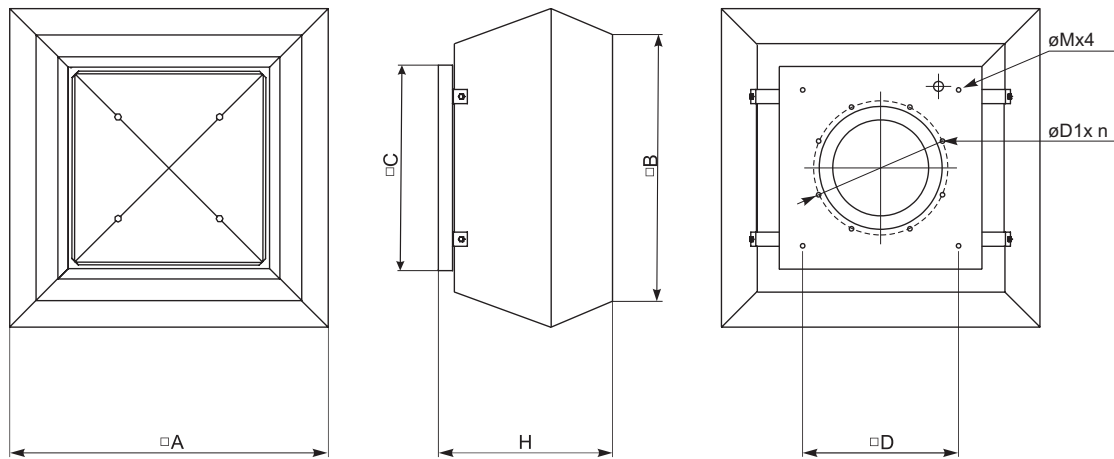

Type	Dimensions [mm]							
	$\square A$	$\square B$	$\square C$	H	ϕM	$\square D$	$\phi D1$	n
VSV 250	415	320	355	275	M6	245	230	6
VSV 311	555	470	435	323	M6	330	285	6
VSV 355	720	618	595	420	M10	450	438	6
VSV 400	720	618	595	420	M10	450	438	6
VSV 450	900	700	665	485	M10	535	438	6
VSV 500	900	700	665	485	M10	535	438	6
VSV 560	1150	972	939	609	M10	750	605	8
VSV 630	1150	972	939	609	M10	750	605	8
VSV 710	1350	1176	1040	717	M10	840	674	8

Type	Dimensions [mm]							
	$\square A$	$\square B$	$\square C$	H	ϕM	$\square D$	$\phi D1$	n
VSVI 311	675	567	435	369	M6	330	285	6
VSVI 355	844	716	595	422	M10	450	438	6
VSVI 400	844	716	595	422	M10	450	438	6
VSVI 450	966	817	665	488	M10	535	438	6
VSVI 500	966	817	665	488	M10	535	438	6
VSVI 560	1265	1033	939	611	M10	750	605	8
VSVI 630	1265	1033	939	611	M10	750	605	8
VSVI 710	1447	1178	1040	747	M10	840	674	8

Type	Accessories									
	TGRV	TGRT	ETY/MTY	KS-K	KSP-K	FSV	LSV	ATS	Main switch	
VSV 250-2 L1	1,5	-	1,5	250	250	250	250	250	BWS316 Y TPN	
VSV 250-2S L1	1,5	-	1,5	250	250	250	250	250	BWS316 Y TPN	
VSV/VSVI 311-4 L1	1,5	-	1,5	311	311	311	311	311	BWS316 Y TPN	
VSV/VSVI 311-4 L3	-	1	-	311	311	311	311	311	BWS316 Y TPN	
VSV/VSVI 355-4 L1	2	-	2,5	355/400	355/400	355-500	355/500	355/500	BWS316 Y TPN	
VSV/VSVI 355-4 L3	-	1	-	355/400	355/400	355-500	355/500	355/500	BWS316 Y TPN	
VSV/VSVI 400-4 L1	3	-	4	355/400	355/400	355-500	355/500	355/500	BWS316 Y TPN	
VSV/VSVI 400-4 L3	-	1	-	355/400	355/400	355-500	355/500	355/500	BWS316 Y TPN	
VSV/VSVI 450-4 L1	5	-	-	450/500	450/500	355-500	355/500	355/500	BWS316 Y TPN	
VSV/VSVI 450-4 L3	-	2	-	450/500	450/500	355-500	355/500	355/500	BWS316 Y TPN	
VSV/VSVI 450-6 L1	-	-	-	450/500	450/500	355-500	355/500	355/500	BWS316 Y TPN	
VSV/VSVI 450-6 L3	-	1	-	450/500	450/500	355-500	355/500	355/500	BWS316 Y TPN	
VSV/VSVI 500-4 L3	-	4	-	450/500	450/500	355-500	355/500	355/500	BWS316 Y TPN	
VSV/VSVI 500-6 L3	-	2	-	450/500	450/500	355-500	355/500	355/500	BWS316 Y TPN	
VSV/VSVI 560-4 L3	-	5	-	560/630	560/630	560-630	560/630	560/630	BWS316 Y TPN	
VSV/VSVI 560-6 L3	-	2	-	560/630	560/630	560-630	560/630	560/630	BWS316 Y TPN	
VSV/VSVI 630-4 L3	-	11	-	560/630	560/630	560-630	560/630	560/630	BWS316 Y TPN	
VSV/VSVI 630-6 L3	-	4	-	560/630	560/630	560-630	560/630	560/630	BWS316 Y TPN	
VSV/VSVI 630-8 L3	-	2	-	560/630	560/630	560-630	560/630	560/630	BWS316 Y TPN	
VSV/VSVI 710-6 L3	-	7	-	710	710	710	710	710	BWS316 Y TPN	
VSV/VSVI 710-8 L3	-	3	-	710	710	710	710	710	BWS316 Y TPN	

Accessories



VSV 250-2 L1

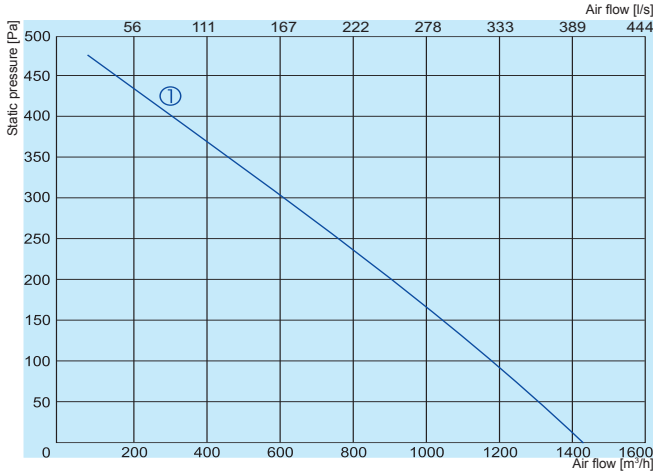

① — 230V

VSV 250-2 L1

Inlet
Outlet
Surrounding

Lwa total, dB(A)	Lwa, dB(A)						
	125 Hz	250 Hz	500 Hz	1 kHz	2 kHz	4 kHz	8 kHz
Inlet	67	54	56	61	62	60	59
Outlet	71	56	61	64	67	65	58
Surrounding	65	49	56	57	60	58	46

Measured at 1155 m³/h, 100 Pa

VSV 250-2S L1

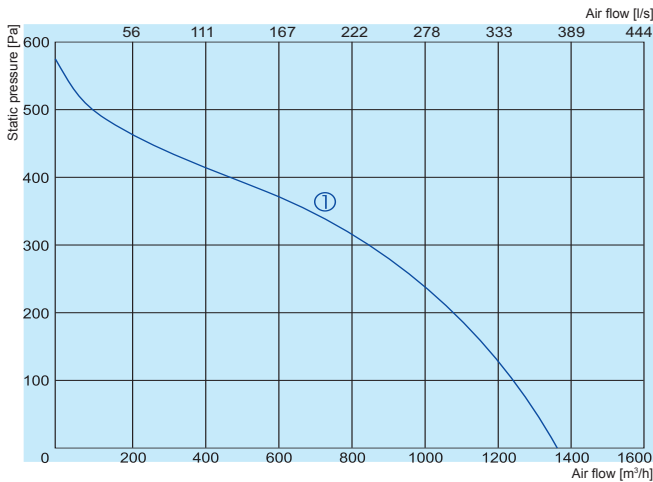

① — 230V

250-2S L1

Inlet
Outlet
Surrounding

Lwa total, dB(A)	Lwa, dB(A)						
	125 Hz	250 Hz	500 Hz	1 kHz	2 kHz	4 kHz	8 kHz
Inlet	67	54	56	61	62	60	54
Outlet	71	56	61	64	67	65	51
Surrounding	65	49	56	57	60	58	46

Measured at 1155 m³/h, 100 Pa

VSV/VSVI 311-4 L1

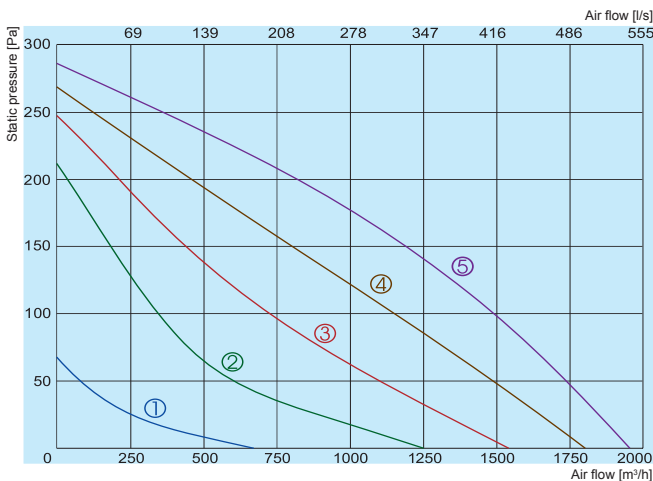

① — 80V

③ — 140V

⑤ — 230V

② — 120V

④ — 170V

VSV 311-4 L1

Inlet
Outlet
Surrounding

Lwa total, dB(A)	Lwa, dB(A)						
	125 Hz	250 Hz	500 Hz	1 kHz	2 kHz	4 kHz	8 kHz
Inlet	69	52	64	66	56	55	41
Outlet	68	52	59	65	60	57	45
Surrounding	71	55	64	69	62	58	46

Measured at 1511 m³/h, 100 Pa

VSVI 311-4 L1

Inlet
Outlet
Surrounding

Lwa total, dB(A)	Lwa, dB(A)						
	125 Hz	250 Hz	500 Hz	1 kHz	2 kHz	4 kHz	8 kHz
Inlet	68	50	63	65	56	53	40
Outlet	67	51	57	64	59	56	43
Surrounding	70	54	64	68	60	58	44

Measured at 1511 m³/h, 100 Pa

The fan characteristic curves were determined in accordance with EN ISO 5801. The sound levels were determined in accordance with DIN 45635 resp. ISO 3744 at a distance of 1 m from the fan.

VSV/VSVI 311-4 L3

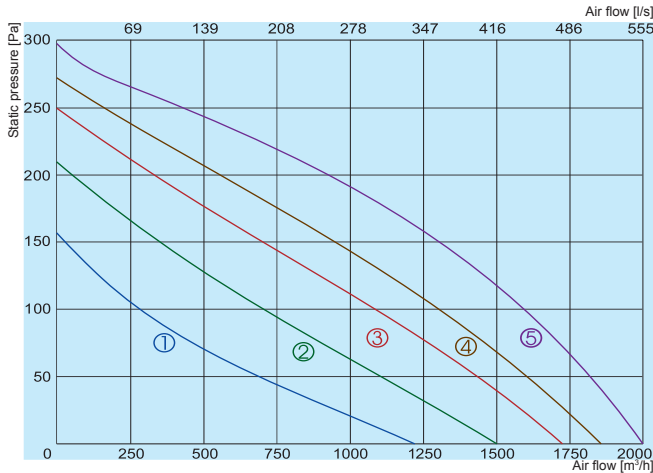

- ① 130V
- ③ 220V
- ⑤ 400V
- ② 170V
- ④ 270V

VSV 311-4 L3

	Lwa, dB(A)						
	125 Hz	250 Hz	500 Hz	1 kHz	2 kHz	4 kHz	8 kHz
Inlet	70	51	62	68	60	52	54
Outlet	69	52	60	67	59	60	53
Surrounding	72	55	63	70	64	57	47

Measured at 1706 m³/h, 75 Pa

VSVI 311-4 L3

	Lwa, dB(A)						
	125 Hz	250 Hz	500 Hz	1 kHz	2 kHz	4 kHz	8 kHz
Inlet	69	50	62	67	58	52	41
Outlet	68	50	59	66	58	53	43
Surrounding	71	54	63	69	62	57	45

Measured at 1706 m³/h, 75 Pa

		250-2 L1	250-2S L1	311-4 L1	311-4 L3
Voltage/Frequency	[V/Hz]	230/50	230/50	230/50	400/50
Power consumption	[kW]	0,23	0,185	0,183	0,153
Current	[A]	1,00	0,81	0,83	0,35
Speed	[min ⁻¹]	2631	2650	1310	1370
Max. airflow	[m³/h]	1428	1350	1957	2010
Min./Max. air temperature	[°C]	-25/50	-25/50	-25/60	-25/60
Weight	[kg]	8,3	8,1	19/26	19/26
Wiring diagram		No. 4	No. 3	No. 1	No. 2
Protection class:	motor	IP-44	IP-44	IP-44	IP-44
	terminal box	IP-54	IP-54	IP-54	IP-54
Comply with ERP 2013		+	-	-	+

VSV/VSVI 355-4 L1

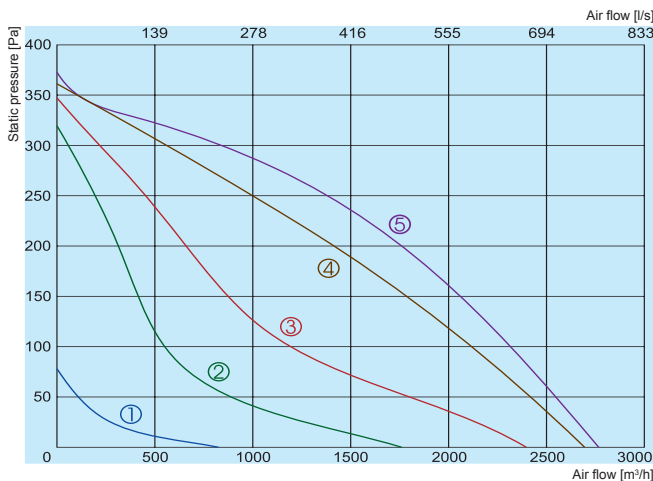

- ① 80V
- ③ 140V
- ⑤ 230V
- ② 120V
- ④ 170V

VSV 355-4 L1

	Lwa, dB(A)						
	125 Hz	250 Hz	500 Hz	1 kHz	2 kHz	4 kHz	8 kHz
Inlet	64	49	57	59	56	55	51
Outlet	66	56	60	57	60	57	53
Surrounding	68	57	61	61	62	58	54

Measured at 2230 m³/h, 124 Pa

VSVI 355-4 L1

	Lwa, dB(A)						
	125 Hz	250 Hz	500 Hz	1 kHz	2 kHz	4 kHz	8 kHz
Inlet	63	48	55	59	55	54	49
Outlet	64	55	58	57	59	56	47
Surrounding	67	56	60	61	60	58	50

Measured at 2230 m³/h, 124 Pa

The fan characteristic curves were determined in accordance with EN ISO 5801. The sound levels were determined in accordance with DIN 45635 resp. ISO 3744 at a distance of 1 m from the fan.

The company reserves the right to make changes of technical data without prior notice

VSV/VSVI 355-4 L3

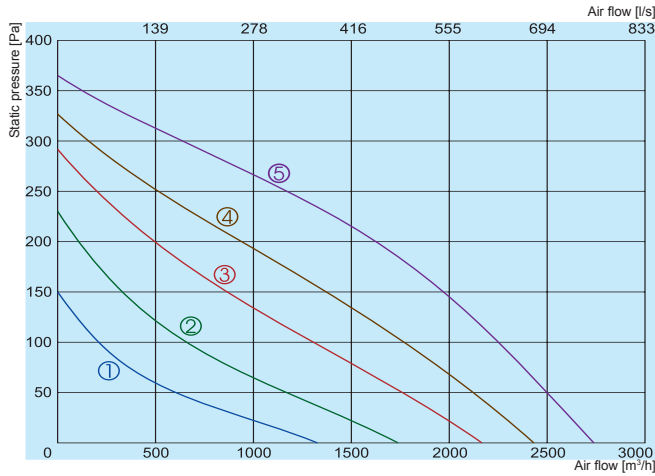

- ① 130V
- ② 170V
- ③ 220V
- ④ 270V
- ⑤ 400V

VSV 355-4 L3

Inlet
Outlet
Surrounding

Lwa total, dB(A)	Lwa, dB(A)						
	125 Hz	250 Hz	500 Hz	1 kHz	2 kHz	4 kHz	8 kHz
Inlet	65	52	56	60	57	57	53
Outlet	66	55	57	60	59	59	51
Surrounding	69	56	58	64	63	59	55

Measured at 2278 m³/h, 102 Pa

VSVI 355-4 L3

Inlet
Outlet
Surrounding

Lwa total, dB(A)	Lwa, dB(A)						
	125 Hz	250 Hz	500 Hz	1 kHz	2 kHz	4 kHz	8 kHz
Inlet	64	51	54	60	56	56	51
Outlet	65	53	56	59	59	57	51
Surrounding	68	55	58	63	61	59	54

Measured at 2278 m³/h, 102 Pa

VSV/VSVI 400-4 L1

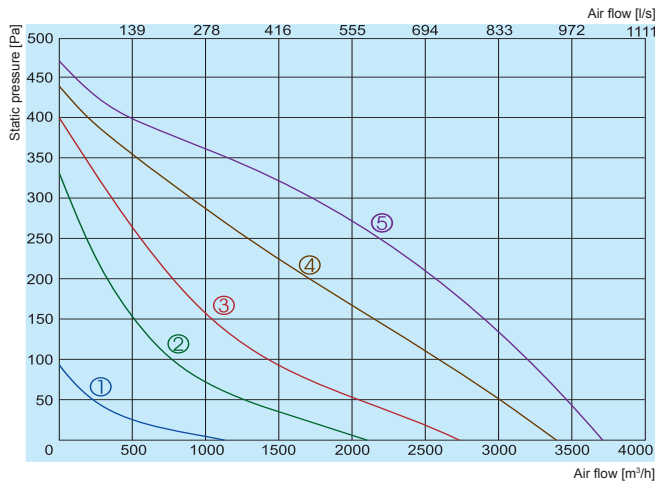

- ① 80V
- ② 120V
- ③ 140V
- ④ 170V
- ⑤ 230V

VSV 400-4 L1

Inlet
Outlet
Surrounding

Lwa total, dB(A)	Lwa, dB(A)						
	125 Hz	250 Hz	500 Hz	1 kHz	2 kHz	4 kHz	8 kHz
Inlet	70	56	67	64	59	57	56
Outlet	69	58	63	61	62	59	52
Surrounding	72	60	67	66	64	61	56

Measured at 2897 m³/h, 160 Pa

VSVI 400-4 L1

Inlet
Outlet
Surrounding

Lwa total, dB(A)	Lwa, dB(A)						
	125 Hz	250 Hz	500 Hz	1 kHz	2 kHz	4 kHz	8 kHz
Inlet	69	54	66	63	57	57	56
Outlet	67	57	61	61	60	58	50
Surrounding	71	59	67	65	62	61	54

Measured at 2897 m³/h, 160 Pa

VSV/VSVI 400-4 L3

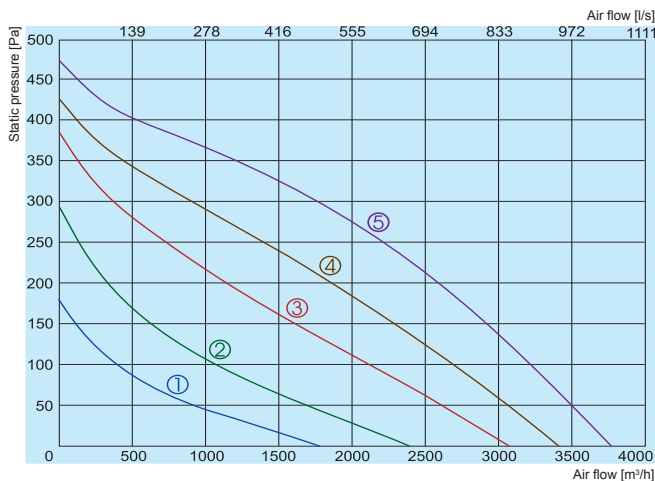

- ① 130V
- ② 170V
- ③ 220V
- ④ 270V
- ⑤ 400V

VSV 400-4 L3

Inlet
Outlet
Surrounding

Lwa total, dB(A)	Lwa, dB(A)						
	125 Hz	250 Hz	500 Hz	1 kHz	2 kHz	4 kHz	8 kHz
Inlet	70	55	65	66	61	56	54
Outlet	70	57	65	63	60	61	52
Surrounding	73	59	69	67	64	63	55

Measured at 3009 m³/h, 145 Pa

VSVI 400-4 L3

Inlet
Outlet
Surrounding

Lwa total, dB(A)	Lwa, dB(A)						
	125 Hz	250 Hz	500 Hz	1 kHz	2 kHz	4 kHz	8 kHz
Inlet	69	54	65	65	59	56	52
Outlet	68	56	63	63	59	60	50
Surrounding	72	58	69	66	62	63	53

Measured at 3009 m³/h, 145 Pa

The fan characteristic curves were determined in accordance with EN ISO 5801. The sound levels were determined in accordance with DIN 45635 resp. ISO 3744 at a distance of 1 m from the fan.

		355-4 L1	355-4 L3	400-4 L1	400-4 L3
Voltage/Frequency	[V/Hz]	230/50	400/50	230/50	400/50
Power consumption	[kW]	0,270	0,243	0,451	0,436
Current	[A]	1,3	0,48	2,15	0,81
Speed	[min ⁻¹]	1390	1340	1280	1320
Max. airflow	[m ³ /h]	2770	2740	3710	3770
Min./Max. air temperature	[°C]	-25/60	-25/60	-25/60	-25/60
Weight	[kg]	31/39	31/38	33/42	32/41
Wiring diagram		No. 1	No. 2	No. 1	No. 2
Protection class:	motor	IP-54	IP-54	IP-54	IP-54
	terminal box	IP-54	IP-54	IP-54	IP-54
Comply with ERP 2013		+	+	-	+

VSV/VSVI 450-4 L1

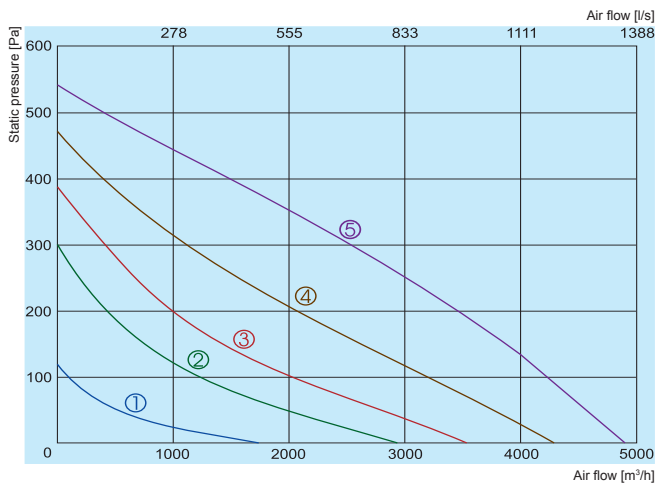

- ① 80V
- ② 120V
- ③ 140V
- ④ 170V
- ⑤ 230V

VSV 450-4 L1

Inlet
Outlet
Surrounding

Lwa total, dB(A)	Lwa, dB(A)							
	125 Hz	250 Hz	500 Hz	1 kHz	2 kHz	4 kHz	8 kHz	
Inlet	72	57	66	69	60	62	62	55
Outlet	73	59	66	68	61	65	65	55
Surrounding	76	61	71	71	68	64	65	57

Measured at 4111 m³/h, 118 Pa

VSVI 450-4 L1

Inlet
Outlet
Surrounding

Lwa total, dB(A)	Lwa, dB(A)							
	125 Hz	250 Hz	500 Hz	1 kHz	2 kHz	4 kHz	8 kHz	
Inlet	71	55	65	68	60	60	62	54
Outlet	72	58	64	68	60	64	63	52
Surrounding	75	60	71	70	66	64	64	55

Measured at 4111 m³/h, 118 Pa

VSV/VSVI 450-4 L3

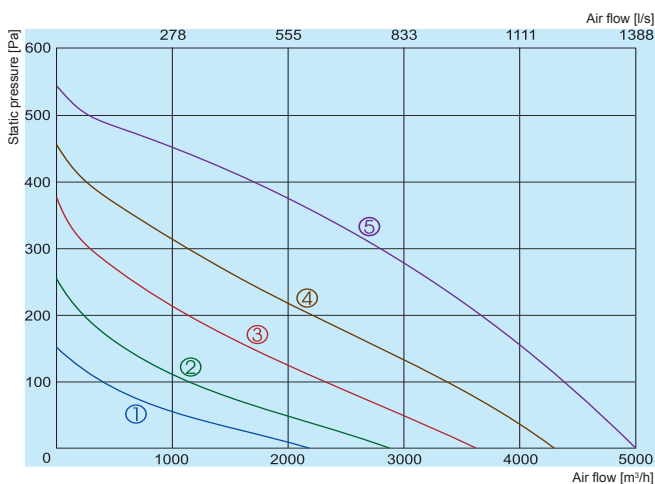

- ① 130V
- ② 170V
- ③ 220V
- ④ 270V
- ⑤ 400V

VSV 450-4 L3

Inlet
Outlet
Surrounding

Lwa total, dB(A)	Lwa, dB(A)							
	125 Hz	250 Hz	500 Hz	1 kHz	2 kHz	4 kHz	8 kHz	
Inlet	73	56	64	71	61	60	63	54
Outlet	74	57	67	69	59	66	66	53
Surrounding	77	64	71	73	68	64	63	59

Measured at 4299 m³/h, 120 Pa

VSVI 450-4 L3

Inlet
Outlet
Surrounding

Lwa total, dB(A)	Lwa, dB(A)							
	125 Hz	250 Hz	500 Hz	1 kHz	2 kHz	4 kHz	8 kHz	
Inlet	72	54	63	70	61	58	63	53
Outlet	73	56	65	69	58	65	64	51
Surrounding	76	63	71	72	66	62	63	57

Measured at 4299 m³/h, 120 Pa

The fan characteristic curves were determined in accordance with EN ISO 5801. The sound levels were determined in accordance with DIN 45635 resp. ISO 3744 at a distance of 1 m from the fan.

VSV/VSVI 450-6 L1

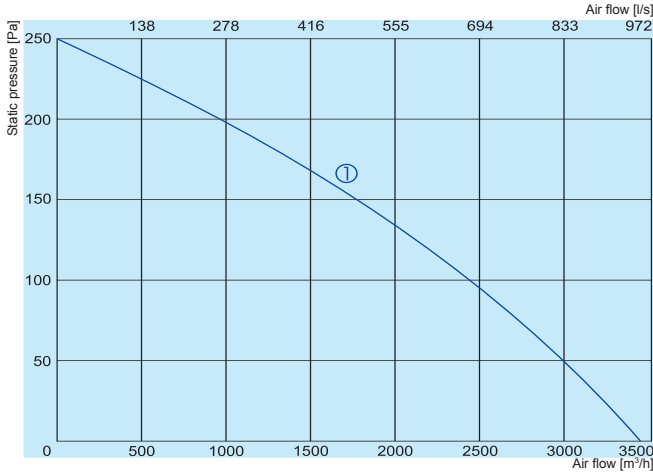

① — 230V

VSV 450-6 L1

Inlet
Outlet
Surrounding

LWA total, dB(A)	Lwa, dB(A)						
	125 Hz	250 Hz	500 Hz	1 kHz	2 kHz	4 kHz	8 kHz
Inlet	63	50	57	57	55	54	51
Outlet	64	52	56	58	58	57	49
Surrounding	66	54	58	61	62	57	53

Measured at 2287 m³/h, 116 Pa

VSVI 450-6 L1

Inlet
Outlet
Surrounding

LWA total, dB(A)	Lwa, dB(A)						
	125 Hz	250 Hz	500 Hz	1 kHz	2 kHz	4 kHz	8 kHz
Inlet	62	49	55	57	54	53	49
Outlet	63	50	55	57	58	55	49
Surrounding	65	53	58	60	60	57	52

Measured at 2287 m³/h, 116 Pa

VSV/VSVI 450-6 L3

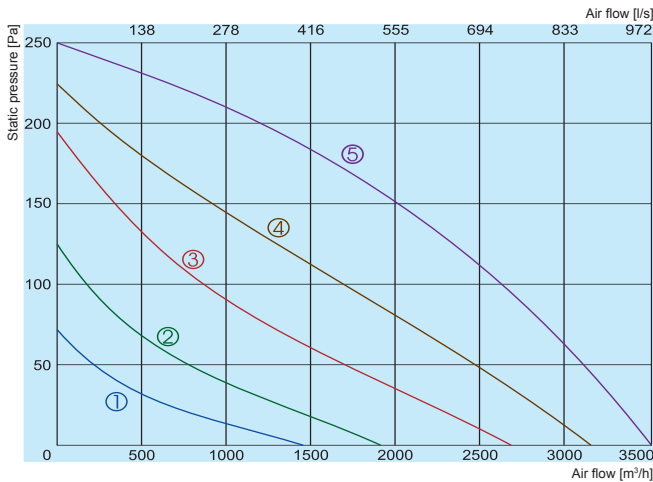

① — 130V

③ — 220V

⑤ — 400V

② — 170V

④ — 270V

VSV 450-6 L3

Inlet
Outlet
Surrounding

LWA total, dB(A)	Lwa, dB(A)						
	125 Hz	250 Hz	500 Hz	1 kHz	2 kHz	4 kHz	8 kHz
Inlet	61	50	53	56	54	52	47
Outlet	63	51	57	57	55	56	48
Surrounding	65	53	60	59	58	57	52

Measured at 2033 m³/h, 150 Pa

VSVI 450-6 L3

Inlet
Outlet
Surrounding

LWA total, dB(A)	Lwa, dB(A)						
	125 Hz	250 Hz	500 Hz	1 kHz	2 kHz	4 kHz	8 kHz
Inlet	60	49	53	55	52	52	46
Outlet	62	49	56	56	55	54	48
Surrounding	64	52	58	59	57	56	50

Measured at 2033 m³/h, 150 Pa

		450-4 L1	450-4 L3	450-6 L1	450-6 L3
Voltage/Frequency	[V/Hz]	230/50	400/50	230/50	400/50
Power consumption	[kW]	0,628	0,652	0,243	0,267
Current	[A]	2,87	1,32	1,06	0,61
Speed	[min ⁻¹]	1230	1250	920	880
Max. airflow	[m³/h]	4880	5050	3440	3530
Min./Max. air temperature	[°C]	-25/60	-25/60	-25/60	-25/60
Weight	[kg]	50/62,5	48/61	48,5/62,5	47/59,5
Wiring diagram		No. 1	No. 2	No. 1	No. 2
Protection class:	motor	IP-54	IP-54	IP-54	IP-54
	terminal box	IP-54	IP-54	IP-54	IP-54
Comply with ERP 2013		-	-	-	-

The fan characteristic curves were determined in accordance with EN ISO 5801. The sound levels were determined in accordance with DIN 45635 resp. ISO 3744 at a distance of 1 m from the fan.

VSV/VSVI 500-4 L3

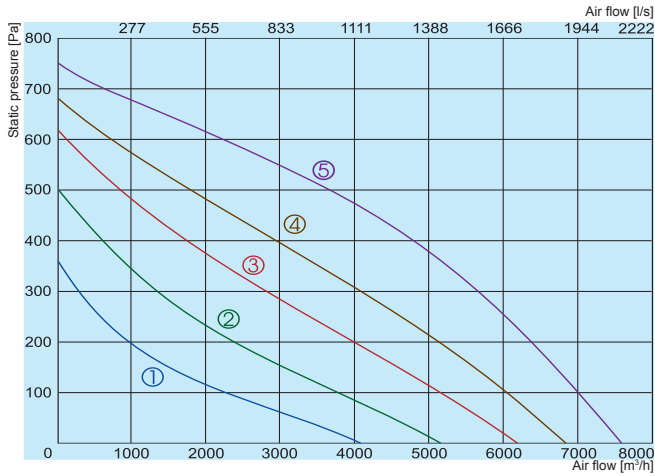

- ① 130V
- ② 170V
- ③ 220V
- ④ 270V
- ⑤ 400V

VSV 500-4 L3

LWA total, dB(A)	Lwa, dB(A)							
	125 Hz	250 Hz	500 Hz	1 kHz	2 kHz	4 kHz	8 kHz	
Inlet	81	66	74	78	72	72	69	67
Outlet	83	67	77	78	75	73	73	68
Surrounding	85	70	77	81	79	74	73	72

Measured at 6732 m³/h, 150 Pa

VSVI 500-4 L3

LWA total, dB(A)	Lwa, dB(A)							
	125 Hz	250 Hz	500 Hz	1 kHz	2 kHz	4 kHz	8 kHz	
Inlet	80	64	73	77	72	70	69	65
Outlet	82	66	75	78	74	72	71	66
Surrounding	84	69	77	80	78	74	72	70

Measured at 6732 m³/h, 150 Pa

VSV/VSVI 500-6 L3

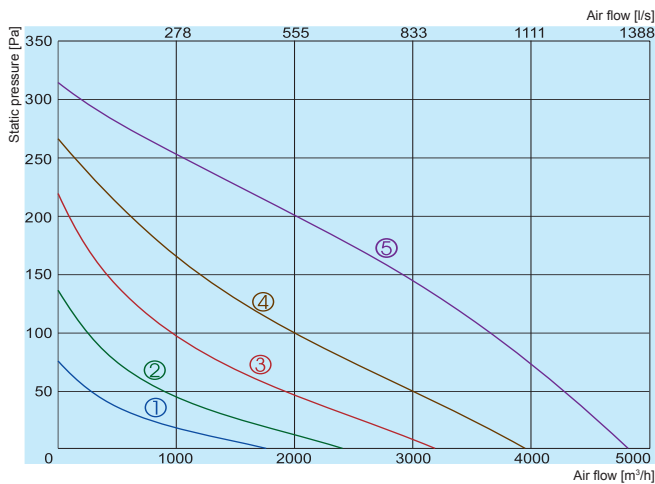

- ① 130V
- ② 170V
- ③ 220V
- ④ 270V
- ⑤ 400V

VSV 500-6 L3

LWA total, dB(A)	Lwa, dB(A)							
	125 Hz	250 Hz	500 Hz	1 kHz	2 kHz	4 kHz	8 kHz	
Inlet	62	53	57	54	54	55	50	46
Outlet	66	51	64	56	56	57	52	45
Surrounding	68	55	64	59	60	58	55	50

Measured at 3152 m³/h, 137 Pa

VSVI 500-6 L3

LWA total, dB(A)	Lwa, dB(A)							
	125 Hz	250 Hz	500 Hz	1 kHz	2 kHz	4 kHz	8 kHz	
Inlet	61	51	56	53	54	53	50	45
Outlet	65	49	63	55	56	55	52	44
Surrounding	67	53	64	57	58	57	54	48

Measured at 3152 m³/h, 137 Pa

VSV/VSVI 560-4 L3

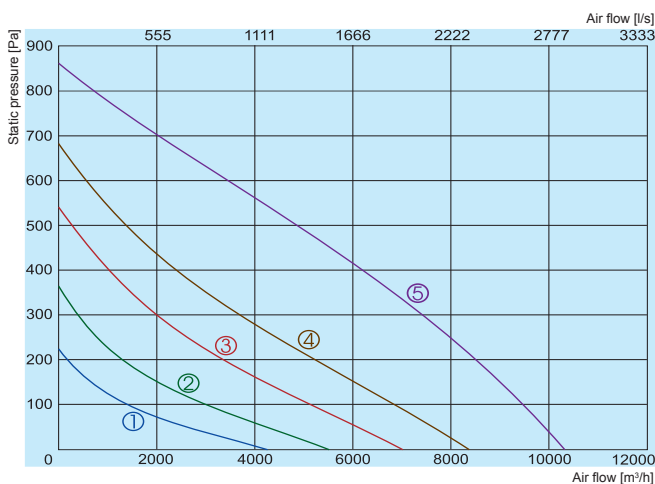

- ① 130V
- ② 170V
- ③ 220V
- ④ 270V
- ⑤ 400V

VSV 560-4 L3

LWA total, dB(A)	Lwa, dB(A)							
	125 Hz	250 Hz	500 Hz	1 kHz	2 kHz	4 kHz	8 kHz	
Inlet	77	69	70	72	69	65	63	62
Outlet	77	69	70	71	68	69	63	57
Surrounding	80	71	73	74	73	70	68	66

Measured at 9047 m³/h, 152 Pa

VSVI 560-4 L3

LWA total, dB(A)	Lwa, dB(A)							
	125 Hz	250 Hz	500 Hz	1 kHz	2 kHz	4 kHz	8 kHz	
Inlet	76	68	70	71	67	65	62	60
Outlet	76	67	69	70	68	67	63	56
Surrounding	79	70	71	74	72	69	66	64

Measured at 9047 m³/h, 152 Pa

The fan characteristic curves were determined in accordance with EN ISO 5801. The sound levels were determined in accordance with DIN 45635 resp. ISO 3744 at a distance of 1 m from the fan.

The company reserves the right to make changes of technical data without prior notice

VSV/VSVI 560-6 L3

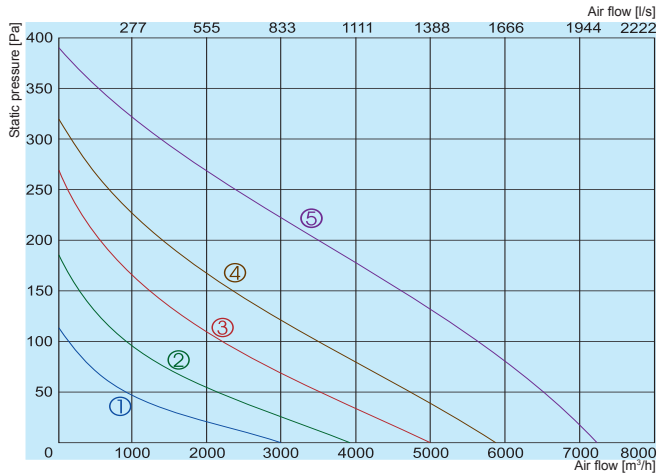

- ① 130V
- ② 170V
- ③ 220V
- ④ 270V
- ⑤ 400V

VSV 560-6 L3

Inlet
Outlet
Surrounding

Lwa total, dB(A)	Lwa, dB(A)						
	125 Hz	250 Hz	500 Hz	1 kHz	2 kHz	4 kHz	8 kHz
Inlet	63	52	57	53	55	55	56
Outlet	63	53	55	58	56	56	53
Surrounding	66	55	58	59	59	58	57

Measured at 4773 m³/h, 169 Pa

VSVI 560-6 L3

Inlet
Outlet
Surrounding

Lwa total, dB(A)	Lwa, dB(A)						
	125 Hz	250 Hz	500 Hz	1 kHz	2 kHz	4 kHz	8 kHz
Inlet	62	51	55	53	54	54	48
Outlet	63	52	55	57	54	56	45
Surrounding	65	54	58	58	57	58	49

Measured at 4773 m³/h, 169 Pa

	500-4 L3	500-6 L3	560-4 L3	560-6 L3
Voltage/Frequency	[V/Hz]	400/50	400/50	400/50
Power consumption	[kW]	1,242	0,388	1,798
Current	[A]	2,31	0,79	3,47
Speed	[min ⁻¹]	1330	840	1180
Max. airflow	[m³/h]	7584	4810	10330
Min./Max. air temperature	[°C]	-25/55	-25/60	-25/50
Weight	[kg]	55,5/65	49/59	90,5/109
Wiring diagram		No. 2	No. 2	No. 2
Protection class:	motor	IP-54	IP-54	IP-54
	terminal box	IP-54	IP-54	IP-54
Comply with ERP 2013		+	-	-

VSV/VSVI 630-4 L3

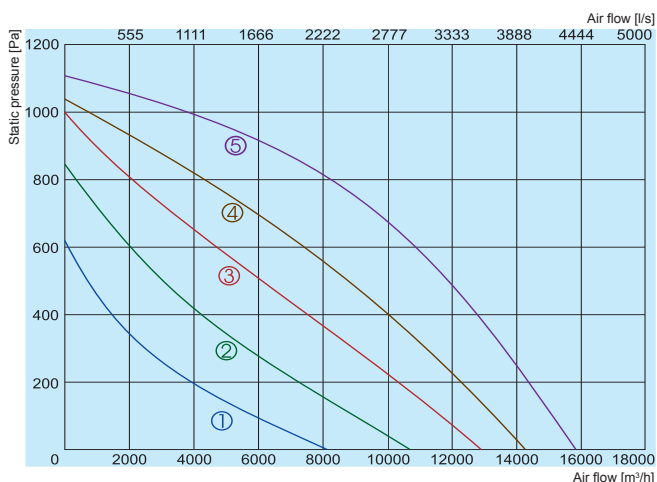

- ① 130V
- ② 170V
- ③ 220V
- ④ 270V
- ⑤ 400V

VSV 630-4 L3

Inlet
Outlet
Surrounding

Lwa total, dB(A)	Lwa, dB(A)						
	125 Hz	250 Hz	500 Hz	1 kHz	2 kHz	4 kHz	8 kHz
Inlet	85	72	77	82	77	77	69
Outlet	87	73	79	83	80	77	73
Surrounding	90	76	82	86	82	79	75

Measured at 14077 m³/h, 242 Pa

VSVI 630-4 L3

Inlet
Outlet
Surrounding

Lwa total, dB(A)	Lwa, dB(A)						
	125 Hz	250 Hz	500 Hz	1 kHz	2 kHz	4 kHz	8 kHz
Inlet	84	70	76	81	77	75	68
Outlet	85	71	77	82	78	76	69
Surrounding	88	74	80	85	79	78	71

Measured at 14077 m³/h, 242 Pa

The fan characteristic curves were determined in accordance with EN ISO 5801. The sound levels were determined in accordance with DIN 45635 resp. ISO 3744 at a distance of 1 m from the fan.

VSV/VSVI 630-6 L3

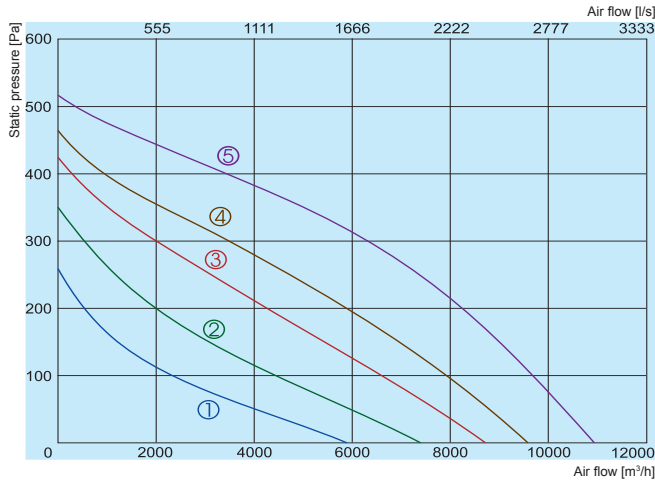

- ① 130V
- ② 170V
- ③ 220V
- ④ 270V
- ⑤ 400V

VSV 630-6 L3

LWA total, dB(A)	Lwa, dB(A)						
	125 Hz	250 Hz	500 Hz	1 kHz	2 kHz	4 kHz	8 kHz
Inlet	73	58	69	68	59	62	58
Outlet	73	59	71	63	62	61	58
Surrounding	75	61	71	70	64	63	62

Measured at 8003 m³/h, 201 Pa

VSVI 630-6 L3

LWA total, dB(A)	Lwa, dB(A)						
	125 Hz	250 Hz	500 Hz	1 kHz	2 kHz	4 kHz	8 kHz
Inlet	72	56	68	67	59	60	57
Outlet	72	58	69	63	60	61	56
Surrounding	74	60	71	69	62	63	60

Measured at 8003 m³/h, 201 Pa

VSV/VSVI 630-8 L3

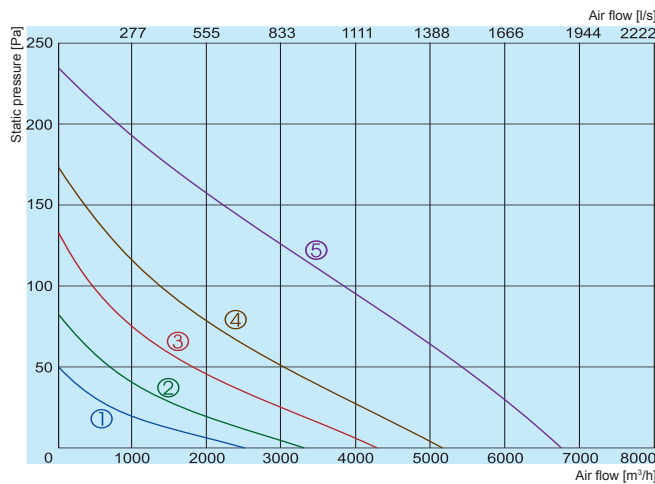

- ① 130V
- ② 170V
- ③ 220V
- ④ 270V
- ⑤ 400V

VSV 630-8 L3

LWA total, dB(A)	Lwa, dB(A)						
	125 Hz	250 Hz	500 Hz	1 kHz	2 kHz	4 kHz	8 kHz
Inlet	63	44	59	45	49	50	37
Outlet	64	48	63	50	49	52	37
Surrounding	66	49	63	52	53	55	40

Measured at 5221 m³/h, 59 Pa

VSVI 630-8 L3

LWA total, dB(A)	Lwa, dB(A)						
	125 Hz	250 Hz	500 Hz	1 kHz	2 kHz	4 kHz	8 kHz
Inlet	61	43	57	45	48	49	35
Outlet	63	46	62	50	48	51	35
Surrounding	65	48	63	51	51	53	38

Measured at 5221 m³/h, 59 Pa

VSV/VSVI 710-6 L3

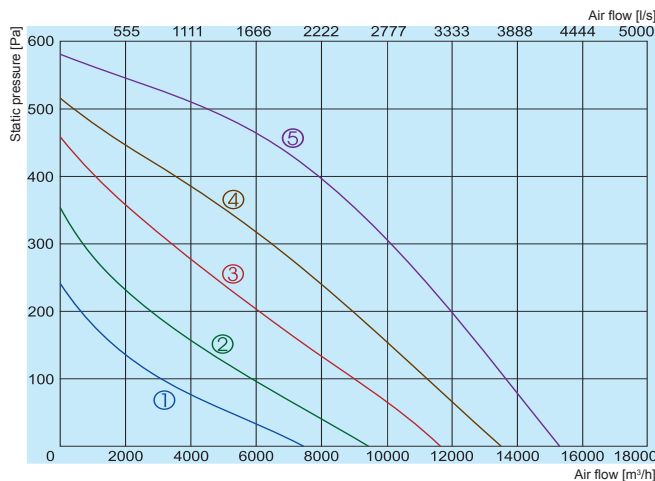

- ① 130V
- ② 170V
- ③ 220V
- ④ 270V
- ⑤ 400V

VSV 710-6 L3

LWA total, dB(A)	Lwa, dB(A)						
	125 Hz	250 Hz	500 Hz	1 kHz	2 kHz	4 kHz	8 kHz
Inlet	84	70	76	80	75	75	69
Outlet	84	70	74	81	77	74	71
Surrounding	87	73	76	83	79	78	72

Measured at 12590 m³/h, 160 Pa

VSVI 710-6 L3

LWA total, dB(A)	Lwa, dB(A)						
	125 Hz	250 Hz	500 Hz	1 kHz	2 kHz	4 kHz	8 kHz
Inlet	83	68	74	79	75	73	68
Outlet	83	69	74	80	75	74	69
Surrounding	85	71	75	82	77	76	71

Measured at 12590 m³/h, 160 Pa

The fan characteristic curves were determined in accordance with EN ISO 5801. The sound levels were determined in accordance with DIN 45635 resp. ISO 3744 at a distance of 1 m from the fan.

VSV/VSVI 710-8 L3

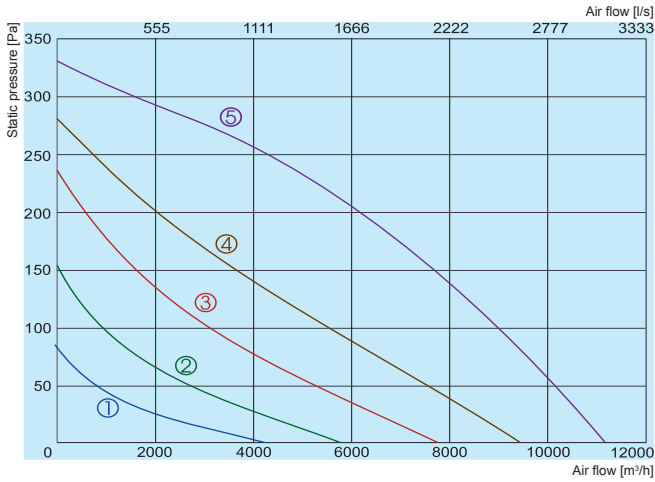

- ① 130V
- ② 170V
- ③ 220V
- ④ 270V
- ⑤ 400V

VSV 710-8 L3

Inlet
Outlet
Surrounding

LWA total, dB(A)	Lwa, dB(A)						
	125 Hz	250 Hz	500 Hz	1 kHz	2 kHz	4 kHz	8 kHz
Inlet	75	59	73	62	67	60	62
Outlet	75	60	73	65	67	62	59
Surrounding	78	63	76	67	69	66	63

Measured at 8948 m³/h, 100 Pa

VSVI 710-8 L3

Inlet
Outlet
Surrounding

LWA total, dB(A)	Lwa, dB(A)						
	125 Hz	250 Hz	500 Hz	1 kHz	2 kHz	4 kHz	8 kHz
Inlet	75	58	73	61	65	60	60
Outlet	74	59	71	65	66	61	57
Surrounding	77	61	75	66	69	64	62

Measured at 8948 m³/h, 100 Pa

		630-4 L3	630-6 L3	630-8 L3	710-6 L3	710-8 L3
Voltage/Frequency	[V/Hz]	400/50	400/50	400/50	400/50	400/50
Power consumption	[kW]	4,137	1,240	0,393	2,00	0,99
Current	[A]	7,18	2,73	0,9	3,9	1,93
Speed	[min ⁻¹]	1360	880	520	890	650
Max. airflow	[m³/h]	15900	10890	6750	15300	11215
Min./Max. air temperature	[°C]	-25/50	-25/60	-25/60	-25/40	-25/40
Weight	[kg]	124/140	109/123,5	101/117,5	156/207	147,5/198,5
Wiring diagram		No. 2	No. 2	No. 2	No. 2	No. 2
Protection class:	motor	IP-54	IP-54	IP-54	IP-54	IP-54
	terminal box	IP-54	IP-54	IP-54	IP-54	IP-54
Comply with ERP 2013		+	-	-	-	-

The fan characteristic curves were determined in accordance with EN ISO 5801. The sound levels were determined in accordance with DIN 45635 resp. ISO 3744 at a distance of 1 m from the fan.

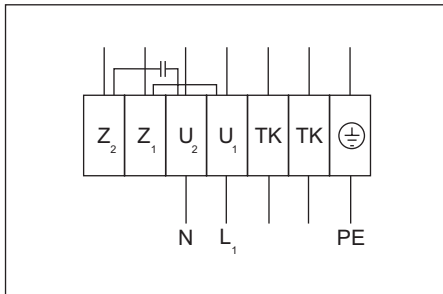

Wiring diagram No. 1 (1~230V)

- U₁ - brown
- U₂ - blue
- Z₁ - black
- Z₂ - orange
- TK - white
- PE - yellow-green

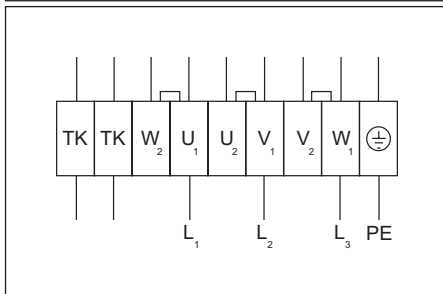

Wiring diagram No. 2 (Δ - 3~230V)

- U₁ - brown
- V₁ - blue
- W₁ - black
- U₂ - red
- V₂ - grey
- W₂ - orange
- TK - white
- PE - yellow-green

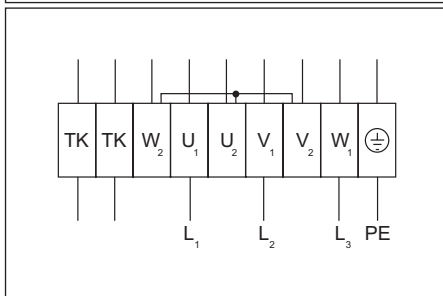

Wiring diagram No. 2 (Y - 3~400V)

- U₁ - brown
- V₁ - blue
- W₁ - black
- U₂ - red
- V₂ - grey
- W₂ - orange
- TK - white
- PE - yellow-green

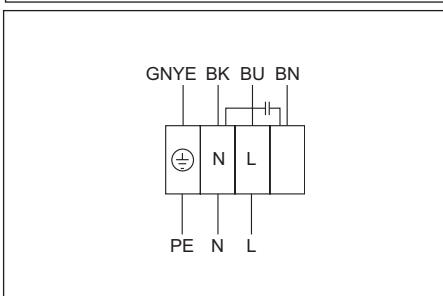

Wiring diagram No. 3 (1~230V)

- GNYE - green-yellow
- BK - black
- BU - blue
- BN - brown
- PE - yellow-green

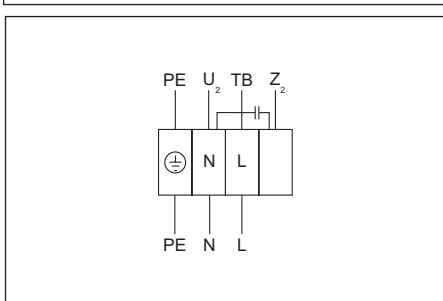

Wiring diagram No. 4 (1~230V)

- U₂ - blue or grey
- Z₂ - black
- TB - brown
- PE - yellow-green