

KUB

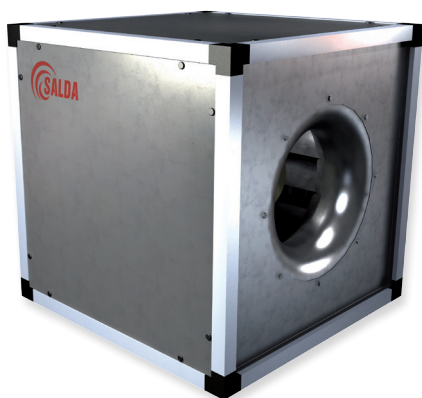

Acoustically insulated fans

Kvadratiniai akustiniai ventiliatoriai

Wentylatory izolowane akustycznie

Канальные акустические вентиляторы



Acoustically insulated duct fans for ventilation and air conditioning systems. Used for the air supply or extract. Additional insulation of the fan box reduces noise level to the surroundings. Not suitable for polluted air, aggressive and explosive gases.

Impeller: backward curved wings.

Motor: external rotor, direct transmission, long-serving bearing with no maintenance requirements.

Housing: made of galvanized steel, housing frame made of aluminium profiles, perforated sheet, which reduces noise level in duct systems.

Sound insulation: mineral wool, 25 mm thickness.

Low noise level.



Kanaliniai, akustiniai ventiliatoriai, skirti vėdinimo ir oro kondicionavimo sistemoms, jungiami prie ortakių. Naudojami oro tiekimui ir šalinimui. Nenaudojami užteršto oro, agresyvių, sprogių dujų transportavimui.

Sparnuotė: atgal lenktais sparneliais, cinkuoto plieno.

Variklis: išorinis rotorius, integruota termokontaktinė variklio apsauga, ilgai tarnaujantys nereikalaujantys priežiūros guoliai.

Korpusas: iš cinkuotos skardos, korpuso rėmas iš aliuminio profilio. Garso izoliacija: mineralinė vata su sustiprintu paviršiumi, 25 mm storio, nedegi

Žemas triukšmo lygis.



Wentylatory izolowane akustycznie z wyjściem okrągłym przystosowane do pracy w instalacjach wentylacji i klimatyzacji. Używane do instalacji nawiewnych i wywiewnych. Dodatkowa izolacja jaką stanowi skrzynka wentylatora zmniejsza poziom hałasu. Nie nadają się do zastosowań w środowiskach agresywnych chemicznie oraz zagrożonych wybuchem. Nie zaleca się stosować w instalacjach zanieczyszczonych cząstkami stałymi, pyłami i odpadami technologicznymi. Nie stosować w instalacjach oddymiania, przeciwpożarowych, spaliniowych.

Wirnik: łopatki zakrzywione do tyłu typu skrzydła.

Silnik: z wirnikiem zewnętrznym, bezpośrednia transmisja, brak wymogów konserwacji.

Obudowa: panele wykonane z blachy ocynkowanej, rama z profili aluminiowych, wewnątrz wykonane z blachy perforowanej, co zmniejsza poziom hałasu w kanale.

Izolacja akustyczna: wełna mineralna, 25 mm grubości.



Канальные акустические вентиляторы для систем вентиляции и кондиционирования, подключаются к воздуховодам. Эксплуатируются в целях подачи и вытяжки воздуха. Не используются при транспортировке загрязнённого воздуха, агрессивных, взрывоопасных газов.

Крыльчатка: загнутые назад лопатки, оцинкованная сталь.

Двигатель: наружный ротор, встроенные термоконтакты двигателя, не требующие ухода подшипники с длительным сроком службы.

Корпус: оцинкованной жести, рама корпуса из алюминиевого профиля.

Звукоизоляция: минеральная вата с усиленной поверхностью, толщиной 25 мм, негорючая.

Низкий уровень шума.

Accessories

Single phase speed controller



TGRV

p. 138

Three phase speed controller



TGRT

p. 139

Single phase speed controller



ETY/MTY

p. 141

Flexible connection



LJ/PG

p. 151

Damper for rectangular ducts

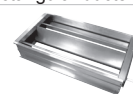

SSK

p. 204

Outdoor grilles



LGd

p. 214

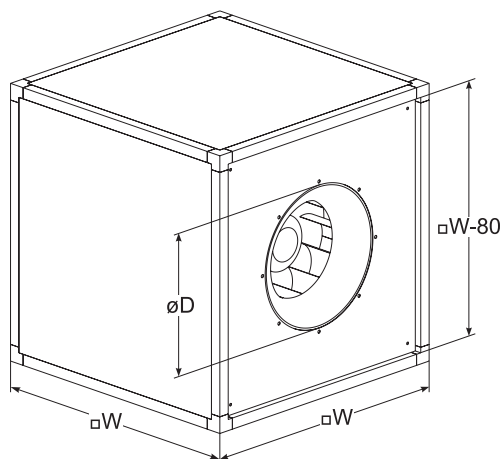

Type	Dimensions [mm]		
	∅D	Nominal diameter of impeller-∅d _n	□ W
KUB 355	292	355	500
KUB 400	325	400	670
KUB 450	365	450	670
KUB 500	410	500	670
KUB 560	460	560	800
KUB 630	510	630	800
KUB 710	580	710	1000

Type	Accessories								
	TGRV	TGRT	ETY/MTY	LJ/PG	SSK	LGd	SSP	Main switch	PR
KUB 355-4-L1	2	-	2,5	420x420	420x420	380xx380	460x460	BWS316 Y TPN	420x420-355
KUB 355-4-L3	-	1	-	420x420	420x420	380xx380	460x460	BWS316 Y TPN	420x420-355
KUB 400-4-L1	3	-	4	590x590	600x600	550x550	630x630	BWS316 Y TPN	590x590-400
KUB 400-4-L3	-	1	-	590x590	600x600	550x550	630x630	BWS316 Y TPN	590x590-400
KUB 450-4-L1	4	-	-	590x590	600x600	550x550	630x630	BWS316 Y TPN	590x590-450
KUB 450-4-L3	-	2	-	590x590	600x600	550x550	630x630	BWS316 Y TPN	590x590-450
KUB 450-6-L1	1,5	-	-	590x590	600x600	550x550	630x630	BWS316 Y TPN	590x590-450
KUB 450-6-L3	-	1	-	590x590	600x600	550x550	630x630	BWS316 Y TPN	590x590-450
KUB 500-4-L3	-	3	-	590x590	600x600	550x550	630x630	BWS316 Y TPN	590x590-500
KUB 500-6-L3	-	1	-	590x590	600x600	550x550	630x630	BWS316 Y TPN	590x590-500
KUB 560-4-L6	-	4	-	720x720	720x720	680x680	760x760	BWS316 Y TPN	695x695-560
KUB 560-6-L3	-	2	-	720x720	720x720	680x680	760x760	BWS316 Y TPN	695x695-560
KUB 630-4-L3	-	7	-	720x720	720x720	680x680	760x760	BWS316 Y TPN	695x695-630
KUB 630-6-L3	-	3	-	720x720	720x720	680x680	760x760	BWS316 Y TPN	695x695-630
KUB 630-8-L3	-	1	-	720x720	720x720	680x680	760x760	BWS316 Y TPN	695x695-630
KUB 710-6-L3	-	5	-	920x920	920x920	880x880	960x960	BWS316 Y TPN	920x920-710
KUB 710-8-L3	-	2	-	920x920	920x920	880x880	960x960	BWS316 Y TPN	920x920-710

Accessories

Rectangular duct silencer

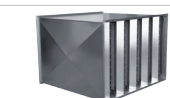

SSP

p. 197

Main switch



Main switch

p. 144

Flange - adapter



PR

p. 154

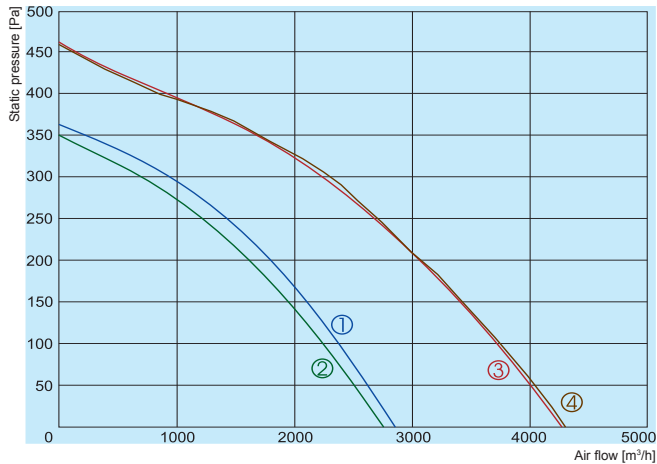

- ① KUB 355-4-L1
- ② KUB 355-4-L3
- ③ KUB 400-4-L1
- ④ KUB 400-4-L3

		355-4-L1	355-4-L3	400-4-L1	400-4-L3
Voltage/Frequency	[V/Hz]	230/50	400/50	230/50	400/50
Power consumption	[kW]	0,27	0,24	0,47	0,45
Current	[A]	1,32	0,46	2,27	0,83
Speed	[min ⁻¹]	1390	1340	1280	1320
Max. airflow	[m ³ /h]	2841	2761	4270	4297
Min./Max. air temperature	[°C]	-25/65	-25/60	-25/40	-25/55
Weight	[kg]	37	37	57	57
Wiring diagram		Nr. 1	Nr. 2	Nr. 1	Nr. 2
Protection class:	motor	IP-54	IP-54	IP-54	IP-54
	terminal box	IP-55	IP-55	IP-55	IP-55
Comply with ERP 2013		+	+	-	+

355-4-L1

	Lwa total, dB(A)	Lwa, dB(A)						
		125 Hz	250 Hz	500 Hz	1 kHz	2 kHz	4 kHz	8 kHz
Inlet	63	48	53	57	55	52	54	56
Outlet	67	49	55	60	62	59	56	55
Surrounding	50	36	42	45	44	42	40	39

Measured at 1968 m³/h, 175 Pa

355-4-L3

	Lwa total, dB(A)	Lwa, dB(A)						
		125 Hz	250 Hz	500 Hz	1 kHz	2 kHz	4 kHz	8 kHz
Inlet	63	46	54	58	53	53	55	55
Outlet	67	48	53	62	60	60	57	54
Surrounding	49	35	43	43	40	41	39	37

Measured at 1802 m³/h, 175 Pa

400-4-L1

	Lwa total, dB(A)	Lwa, dB(A)						
		125 Hz	250 Hz	500 Hz	1 kHz	2 kHz	4 kHz	8 kHz
Inlet	69	57	60	65	60	59	56	63
Outlet	74	57	63	69	70	66	60	63
Surrounding	57	43	49	52	50	47	42	48

Measured at 3409 m³/h, 151 Pa

400-4-L3

	Lwa total, dB(A)	Lwa, dB(A)						
		125 Hz	250 Hz	500 Hz	1 kHz	2 kHz	4 kHz	8 kHz
Inlet	69	57	60	65	60	59	56	63
Outlet	74	57	63	69	70	66	60	63
Surrounding	57	43	49	52	50	47	42	48

Measured at 3429 m³/h, 149 Pa

The fan characteristic curves were determined in accordance with EN ISO 5801. The sound levels were determined in accordance with DIN 45635 resp. ISO 3744 at a distance of 1 m from the fan.

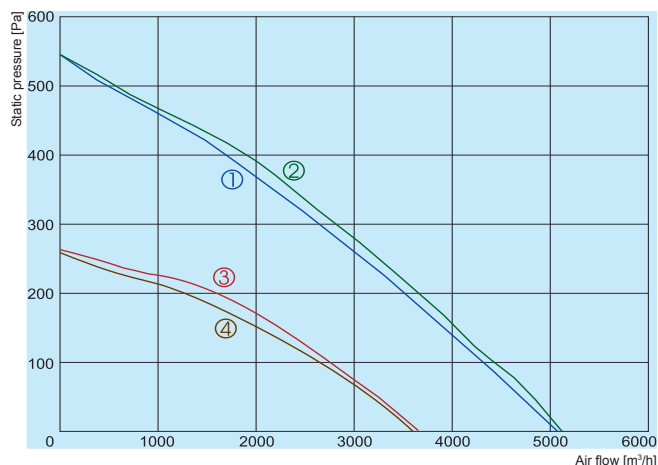

- ① KUB 450-4-L1
- ② KUB 450-4-L3
- ③ KUB 450-6-L1
- ④ KUB 450-6-L3

		450-4-L1	450-4-L3	450-6-L1	450-6-L3
Voltage/Frequency	[V/Hz]	230/50	400/50	230/50	400/50
Power consumption	[kW]	0,62	0,64	0,30	0,26
Current	[A]	2,84	1,35	1,40	0,62
Speed	[min ⁻¹]	1240	1250	920	880
Max. airflow	[m ³ /h]	5065	5138	3671	3606
Min./Max. air temperature	[°C]	-25/60	-25/40	-25/60	-25/60
Weight	[kg]	60	60	60	60
Wiring diagram		Nr. 1	Nr. 2	Nr. 1	Nr. 2
Protection class:	motor	IP-54	IP-54	IP-54	IP-54
	terminal box	IP-55	IP-55	IP-55	IP-55
Comply with ERP 2013		-	-	-	-

450-4-L1

	LWA total, dB(A)	Lwa, dB(A)						
		125 Hz	250 Hz	500 Hz	1 kHz	2 kHz	4 kHz	8 kHz
Inlet	70	58	63	65	61	61	57	62
Outlet	76	58	66	71	71	67	60	59
Surrounding	59	45	53	54	52	49	44	47

Measured at 3827 m³/h, 159 Pa

450-4-L3

	LWA total, dB(A)	Lwa, dB(A)						
		125 Hz	250 Hz	500 Hz	1 kHz	2 kHz	4 kHz	8 kHz
Inlet	71	58	64	66	62	62	57	63
Outlet	77	58	67	72	73	68	61	62
Surrounding	60	45	54	55	54	50	44	49

Measured at 3983 m³/h, 161 Pa

450-6-L1

	LWA total, dB(A)	Lwa, dB(A)						
		125 Hz	250 Hz	500 Hz	1 kHz	2 kHz	4 kHz	8 kHz
Inlet	66	53	61	60	57	55	57	44
Outlet	70	54	63	65	63	61	57	46
Surrounding	54	41	50	49	46	43	42	32

Measured at 2543 m³/h, 121 Pa

450-6-L3

	LWA total, dB(A)	Lwa, dB(A)						
		125 Hz	250 Hz	500 Hz	1 kHz	2 kHz	4 kHz	8 kHz
Inlet	63	50	57	56	55	53	57	40
Outlet	67	51	59	62	62	59	58	42
Surrounding	52	38	46	45	45	41	43	28

Measured at 2385 m³/h, 120 Pa

The fan characteristic curves were determined in accordance with EN ISO 5801. The sound levels were determined in accordance with DIN 45635 resp. ISO 3744 at a distance of 1 m from the fan.

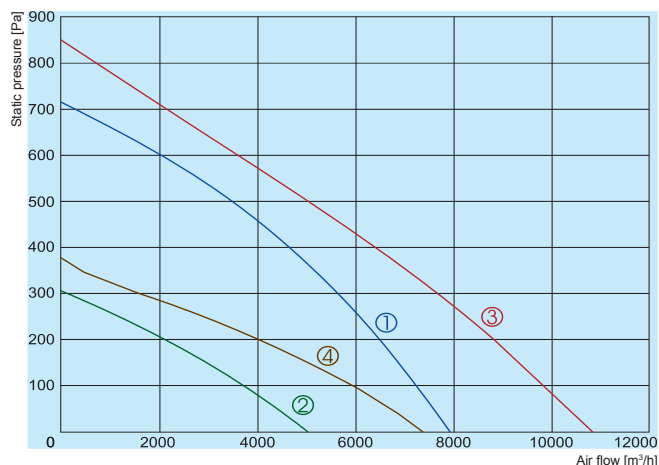

- ① KUB 500-4-L3
- ② KUB 500-6-L3
- ③ KUB 560-4-L3
- ④ KUB 560-6-L3

		500-4-L3	500-6-L3	560-4-L3	560-6-L3
Voltage/Frequency	[V/Hz]	400/50	400/50	400/50	400/50
Power consumption	[kW]	1,21	0,39	1,75	0,61
Current	[A]	2,30	0,84	3,43	1,08
Speed	[min ⁻¹]	1330	840	1180	800
Max. airflow	[m ³ /h]	7886	5030	10855	7377
Min./Max. air temperature	[°C]	-25/45	-25/45	-25/40	-25/40
Weight	[kg]	70	66	117	110
Wiring diagram		Nr. 2	Nr. 2	Nr. 2	Nr. 2
Protection class:	motor	IP-54	IP-54	IP-54	IP-54
	terminal box	IP-55	IP-55	IP-55	IP-55
Comply with ERP 2013		+	-	-	-

500-4-L3

	Lwa total, dB(A)	Lwa, dB(A)						
		125 Hz	250 Hz	500 Hz	1 kHz	2 kHz	4 kHz	8 kHz
Inlet	77	64	70	73	67	68	63	70
Outlet	83	65	74	79	78	74	69	67
Surrounding	64	50	58	60	57	54	49	53

Measured at 6191 m³/h, 240 Pa

500-6-L3

	Lwa total, dB(A)	Lwa, dB(A)						
		125 Hz	250 Hz	500 Hz	1 kHz	2 kHz	4 kHz	8 kHz
Inlet	67	51	66	57	58	52	50	38
Outlet	69	52	66	61	62	57	51	40
Surrounding	55	39	54	45	46	40	36	25

Measured at 2865 m³/h, 160 Pa

560-4-L3

	Lwa total, dB(A)	Lwa, dB(A)						
		125 Hz	250 Hz	500 Hz	1 kHz	2 kHz	4 kHz	8 kHz
Inlet	83	71	75	76	74	74	69	78
Outlet	87	70	79	82	82	79	74	75
Surrounding	69	56	63	63	62	60	55	61

Measured at 8876 m³/h, 202 Pa

560-6-L3

	Lwa total, dB(A)	Lwa, dB(A)						
		125 Hz	250 Hz	500 Hz	1 kHz	2 kHz	4 kHz	8 kHz
Inlet	75	61	67	66	64	65	72	62
Outlet	79	62	70	73	72	70	72	62
Surrounding	63	49	57	56	54	53	57	48

Measured at 5099 m³/h, 149 Pa

The fan characteristic curves were determined in accordance with EN ISO 5801. The sound levels were determined in accordance with DIN 45635 resp. ISO 3744 at a distance of 1 m from the fan.

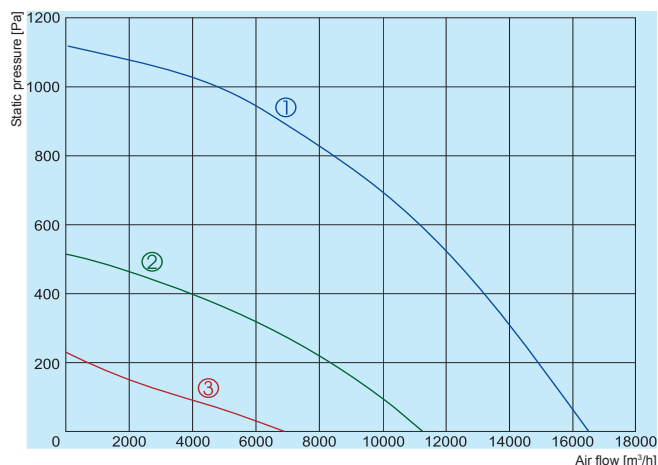

- ① — KUB 630-4-L3
- ② — KUB 630-6-L3
- ③ — KUB 630-8-L3

		630-4-L3	630-6-L3	630-8-L3
Voltage/Frequency	[V/Hz]	400/50	400/50	400/50
Power consumption	[kW]	4,25	1,25	0,38
Current	[A]	7,3	2,66	0,88
Speed	[min ⁻¹]	1360	880	520
Max. airflow	[m³/h]	16500	11288	6908
Min./Max. air temperature	[°C]	-25/40	-25/70	-25/60
Weight	[kg]	145	130	120
Wiring diagram		Nr. 2	Nr. 2	Nr. 2
Protection class:	motor	IP-54	IP-54	IP-54
	terminal box	IP-55	IP-55	IP-55
Comply with ERP 2013		+	+	+

630-4-L3

	Lwa total, dB(A)	Lwa, dB(A)						
		125 Hz	250 Hz	500 Hz	1 kHz	2 kHz	4 kHz	8 kHz
Inlet	88	76	80	81	79	79	74	83
Outlet	92	75	84	87	87	84	79	80
Surrounding	74	61	68	68	67	65	60	66

Measured at 12887 m³/h, 439 Pa

630-6-L3

	Lwa total, dB(A)	Lwa, dB(A)						
		125 Hz	250 Hz	500 Hz	1 kHz	2 kHz	4 kHz	8 kHz
Inlet	80	63	72	71	72	70	70	75
Outlet	85	65	74	78	77	75	80	72
Surrounding	67	46	59	59	61	56	58	58

Measured at 7896 m³/h, 236 Pa

630-8-L3

	Lwa total, dB(A)	Lwa, dB(A)						
		125 Hz	250 Hz	500 Hz	1 kHz	2 kHz	4 kHz	8 kHz
Inlet	69	46	56	51	54	64	67	41
Outlet	72	48	58	60	60	66	69	42
Surrounding	58	36	47	46	48	52	55	30

Measured at 4131 m³/h, 90 Pa

The fan characteristic curves were determined in accordance with EN ISO 5801. The sound levels were determined in accordance with DIN 45635 resp. ISO 3744 at a distance of 1 m from the fan.

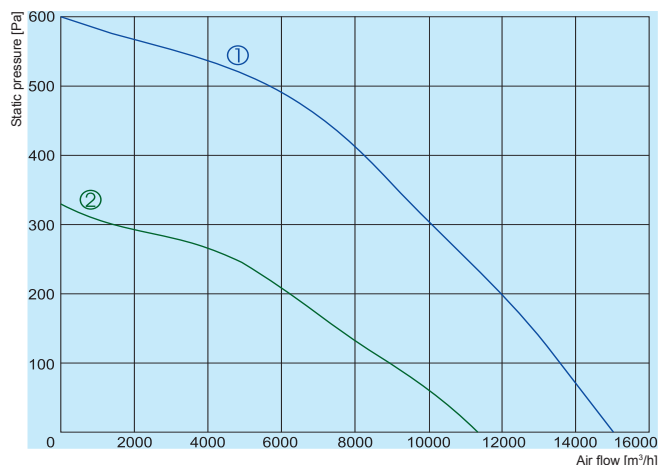

- ① — KUB 710-6-L3
- ② — KUB 710-8-L3

		710-6-L3	710-8-L3
Voltage/Frequency	[V/Hz]	400/50	400/50
Power consumption	[kW]	1,98	0,97
Current	[A]	3,77	2,0
Speed	[min ⁻¹]	890	650
Max. airflow	[m ³ /h]	15000	11326
Min./Max. air temperature	[°C]	-25/40	-25/40
Weight	[kg]	185	170
Wiring diagram		Nr. 2	Nr. 2
Protection class:	motor	IP-54	IP-54
	terminal box	IP-55	IP-55
Comply with ERP 2013		+	-

710-6-L3

	Lwa total, dB(A)	Lwa, dB(A)						
		125 Hz	250 Hz	500 Hz	1 kHz	2 kHz	4 kHz	8 kHz
Inlet	88	74	78	83	80	77	75	82
Outlet	93	75	82	89	88	82	80	79
Surrounding	74	60	66	70	68	62	61	65

Measured at 12555 m³/h, 168 Pa

710-8-L3

	Lwa total, dB(A)	Lwa, dB(A)						
		125 Hz	250 Hz	500 Hz	1 kHz	2 kHz	4 kHz	8 kHz
Inlet	79	70	69	72	75	68	65	68
Outlet	83	68	74	79	77	72	68	72
Surrounding	66	54	58	62	60	53	50	54

Measured at 7661 m³/h, 144 Pa

The fan characteristic curves were determined in accordance with EN ISO 5801. The sound levels were determined in accordance with DIN 45635 resp. ISO 3744 at a distance of 1 m from the fan.

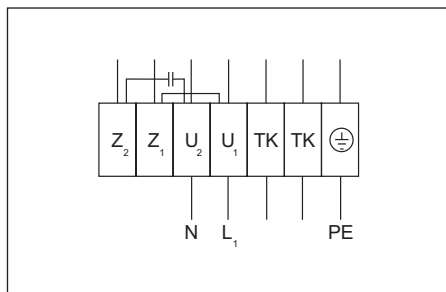

Wiring diagram No. 1 (1~230V)

- U₁ - brown
- U₂ - blue
- Z₁ - black
- Z₂ - orange
- TK - white
- PE - yellow-black

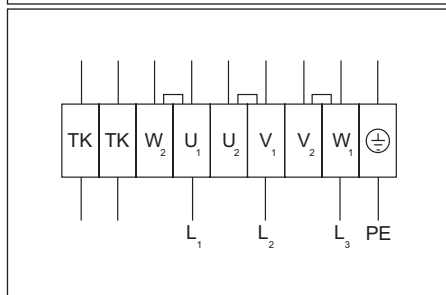

Wiring diagram No. 2 (Δ - 3~230V)

- U₁ - brown
- V₁ - blue
- W₁ - black
- U₂ - red
- V₂ - grey
- W₂ - orange
- TK - white
- PE - green-yellow

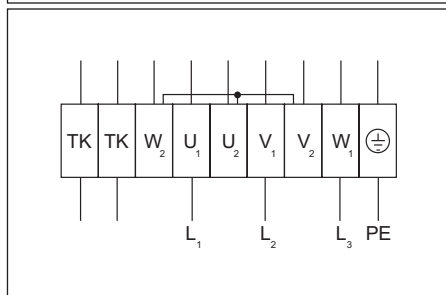

Wiring diagram No. 2 (Y - 3~400V)

- U₁ - brown
- V₁ - blue
- W₁ - black
- U₂ - red
- V₂ - grey
- W₂ - orange
- TK - white
- PE - green-yellow